

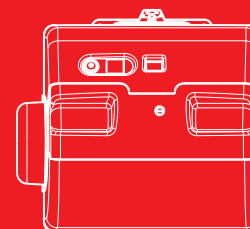

RL Blu Series

Two Stage Low NOx Oil Burners

RL 22 BLU	89/116	÷	261	kW
RL 32 BLU	166/228	÷	356	kW
RL 42 BLU	191/323	÷	600	kW

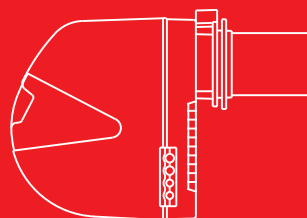

The RL BLU series of burners have been designed for use in hot or superheated water boilers, hot air or steam generators, diathermic oil boilers. The series includes two models with output range from 89 to 356 kW. A servomotor with three adjustable positions guarantees correct air output and air damper closing when the burner is turned off.

The burners are fitted with an electronic device STATUS PANEL, which supplies complete diagnostic: hour meter, ignition meter, identification of trouble shooting. Special care has been paid to keeping overall dimensions compact, to easy servicing, to design and to noise emissions.

The elevated performance of the fans and combustion head, guarantee flexibility of use and excellent working at all firing rates and low NOx emissions.

Technical Data

MODEL			RL 22 BLU	RL 32 BLU	RL 42 BLU
OUTPUT DELIVERY (According to EN 267)	2nd stage (high pressure)	kW	116 - 261	228 - 356	323 - 598
		Mcal/h	100 - 224	196 - 306	278 - 514
		kg/h	9.8 - 22	19.2 - 30	27 - 50.3
	1st stage (low pressure)	kW	89 - 178	166 - 249	191 - 311
		Mcal/h	76,5 - 153	143 - 214	164 - 267
		kg/h	7.5 - 15	14 - 21	16 - 26.2
OUTPUT DELIVERY (According to LRV '92)	2nd stage (high pressure)	kW	130 - 249	237 - 356	
		Mcal/h	112 - 214	204 - 306	
		kg/h	11 - 21	20 - 30	
	1st stage (low pressure)	kW	95 - 178	166 - 249	
		Mcal/h	82 - 153	143 - 214	
		kg/h	8 - 15	14 - 21	
FUEL			Light oil		
- Net calorific value		kWh/kg	11,8		
		Mcal/kg	10,2 (10.200 kcal/kg)		
- Density		kg/dm ³	0,82 - 0,85		
- Viscosity at 20 °C		mm ² /s max	6 (1,5 °E - 6 cSt)		
OPERATION			Intermittent (min. 1 stop in 24 hours) Two-stage (high and low flame) and single-phase (all - nothing)		
NOZZLES		numer	1		
STANDARD APPLICATIONS			Boilers: water, steam, diathermic oil		
AMBIENT TEMPERATURE		°C	0 - 40		
COMBUSTION AIR TEMPERATURE		°C max	60		
ELECTRICAL SUPPLY			~ 50 Hz 230V +/- 10%		230-400V/3/50Hz
ELECTRIC MOTOR		rpm	2800		2800
		W	420		1500
		V	220 - 240		220/240 - 380/415
Running current		A	2,9		4.7 - 2.7
Start-up current		A	11		
MOTOR CAPACITOR		µF/V	12.5/450		
IGNITION TRASFORMER		V1 - V2	230 V - 2 x 5 kV		230 V - 2 x 12 kV
		I1 - I2	1,9 A - 30 mA		0.2 A - 30 mA
CONTROL BOX			RMO 88.53A2		
PUMP SUNTEC AT 2 55 C	delivery (at 12 bar)	kg/h	60		
	pressure range	bar	4 - 25		
	fuel temperature	°C max	60		
ELECTRICAL POWER CONSUMPTION		W max	600	600	1800
ELECTRICAL PROTECTION			IP 44		

Reference conditions:

Temperature: 20°C - Pressure: 1013,5 mbar - Altitude: 0 m a.s.l. - Noise measured at a distance of 1 meter.

Since the Company is constantly engaged in the production improvement, the aesthetic and dimensional features, the technical data, the equipment and the accessories can be changed. This document contains confidential and proprietary information of RIELLO S.p.A. Unless authorised, this information shall not be divulged, nor duplicated in whole or in part.

FIRING RATES

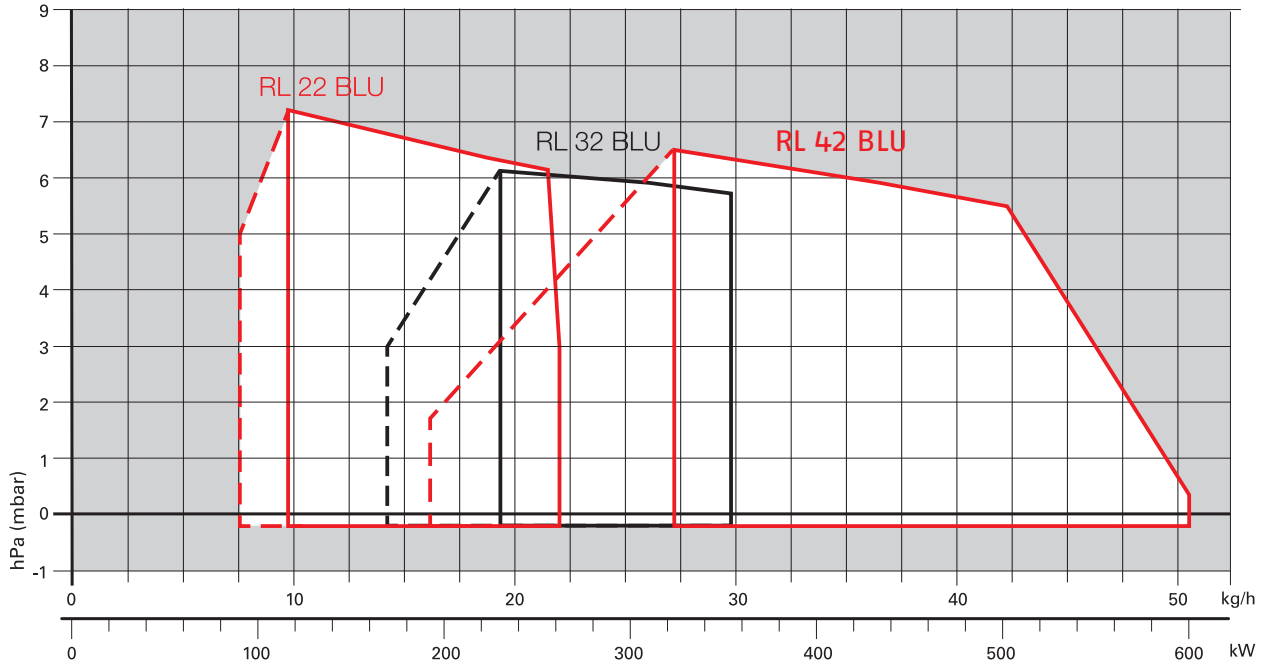

 Useful working field for choosing the burner

 1st stage operation range

Test conditions conforming to EN267

Temperature: 20°C

Pressure: 1013,5 mbar

Altitude: 0 m a.s.l.

Fuel Supply

HYDRAULIC CIRCUITS

The burners are fitted with a pump that controls passage from first to second stage by a pressure jump.

The pump is fitted with a safety valve, supplied on ignition and constantly during working, and a control valve for the passage from low to high pressure.

In first stage the control valve remains open and the fuel reaches the nozzle at low pressure; when the thermostat of the second stage triggers because greater heat is required, the control valve closes allowing the fuel to reach the nozzle at high pressure.

The pump does not need calibrating, as it is set in the factory at 22 bar in high pressure and 9 bar in low pressure; however, both pressure levels can be changed if necessary, by adjusting the regulators fitted on the pump.

The pump has a by-pass that links the return circuit with suction, in the case of single pipe working. The pump is fitted with the by-pass closed, which means it is set for working with two pipes.

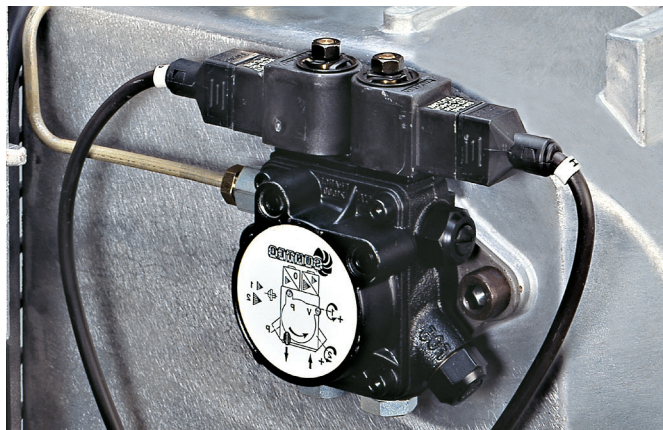

Example of the hydraulic circuit on RL 32 BLU burners

Hydraulic layout of RL BLU burner

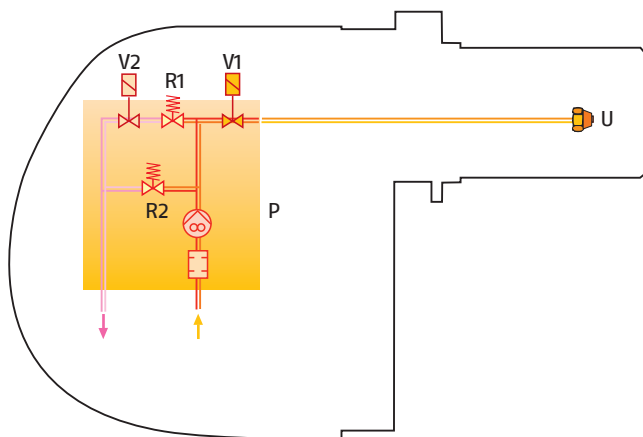

P	Pump with filter and control of two stage output
V2	2nd stage valve (normally open)
R1	1st stage regulator
V1	1st stage valve
U	Nozzle
R2	2nd stage regulator

DIMENSIONING OF THE FUEL SUPPLY LINES

The fuel feed must be completed with the safety devices required by the local norms.

The table shows the choice of piping diameter for the various burners, depending on the difference in height between the burner and the tank and their distance.

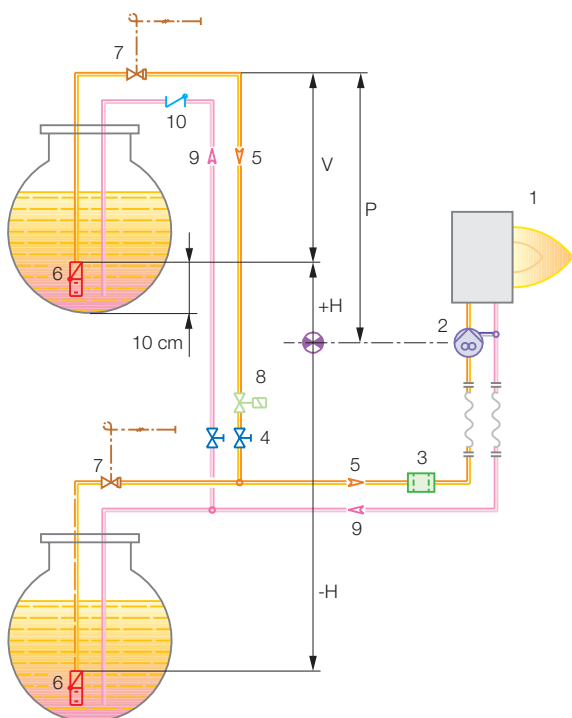

MAXIMUM EQUIVALENT LENGTH FOR THE PIPING L[m]

Diameter piping	Ø8 mm	Ø10 mm	Ø12 mm
+H, -H (m)	L max (m)	L max (m)	Lmax (m)
+4,0	52	134	160
+3,0	46	119	160
+2,0	39	104	160
+ 1,0	33	89	160
+0,5	30	80	160
0	27	73	160
-0,5	24	66	144
-1,0	21	58	128
-2,0	15	43	96
-3,0	8	28	65
-4,0	3	12	33

H	Difference in height pump-foot valve
Ø	Internal pipe diameter
P	Height 10 m
V	Height 4 m
1	Burner
2	Burner pump
3	Filter
4	Manual shut off valve
5	Suction pipework
6	Bottom valve
7	Remote controlled rapid manual shut off valve (compulsory in Italy)
8	Type approved shut off solenoid valve (compulsory in Italy)
9	Return pipework
10	Check valve

With ring distribution oil systems, the feasible drawings and dimensioning are the responsibility of specialised engineering studios, who must check compatibility with the requirements and features of each single installation.

Ventilation

The ventilation circuit produces low noise levels with high performance pressure and air output, in spite of the compact dimensions.

The use of reverse curve blades and sound-proofing material keeps noise level very low.

Air setting through the servomotor guarantees correct fuel output at each working stage.



Example of air setting servomotor

Combustion Head

The combustion head has been designed to create partial smoke recirculation; this way, thanks to lower temperatures reached, NOx emissions are reduced, taking the value below the level allowed by the strictest norms.

Depending on the type of generator, check that the penetration of the head into the combustion chamber is correct.

The internal positioning of the combustion head can easily be adjusted to the maximum defined output by adjusting a screw fixed to the flange.

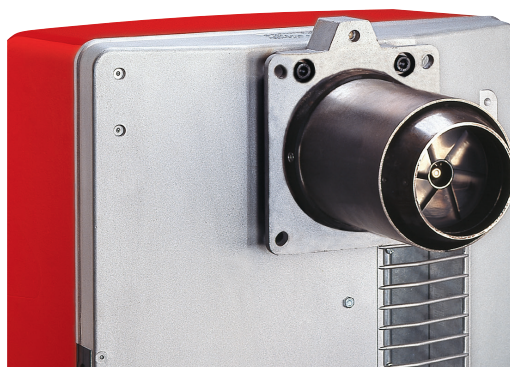

Example of a RL/BLU burner combustion head

DIMENSIONS OF THE COMBUSTION CHAMBER

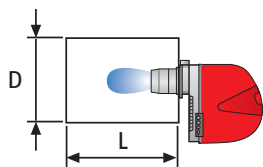

Example:
 Burner thermal output = 2000 kW;
 L combustion chamber (m) = 2,7 m (medium value);
 D combustion chamber (m) = 0,8 m (medium value)

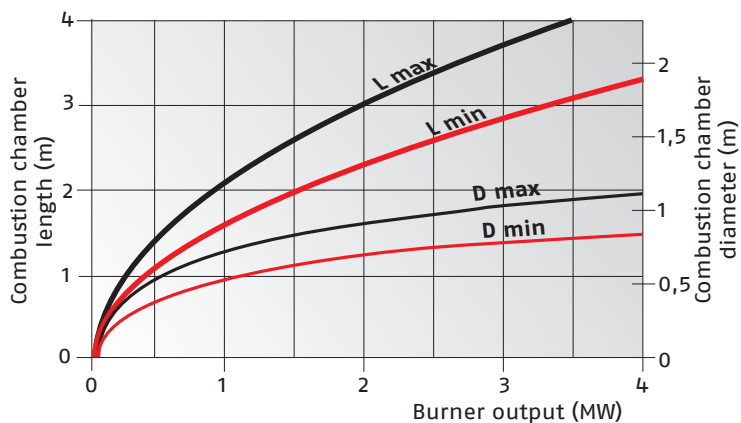

Operation

BURNER OPERATION MODE

With two-stage setting, the RL 22 and 32 BLU burners can follow the temperature load requested by the system.

A modulation ratio of 1.3:1 is reached, thanks to the "pressure jump" technique; the air is adapted to the servomotor rotations.

On "two stage" setting, the burner gradually adjusts output to the requested level, by varying between the two pre-set levels (see picture A).

"TWO STAGE" OPERATION

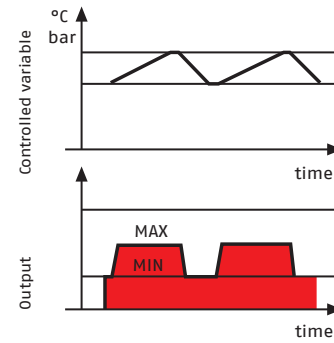

Picture A

Emissions

The emissions of NO₂ and CO have been measured, for the various models, at minimum and maximum output according to EN 267 standard.

Sound emissions have been measured at maximum output.

NO₂ EMISSIONS

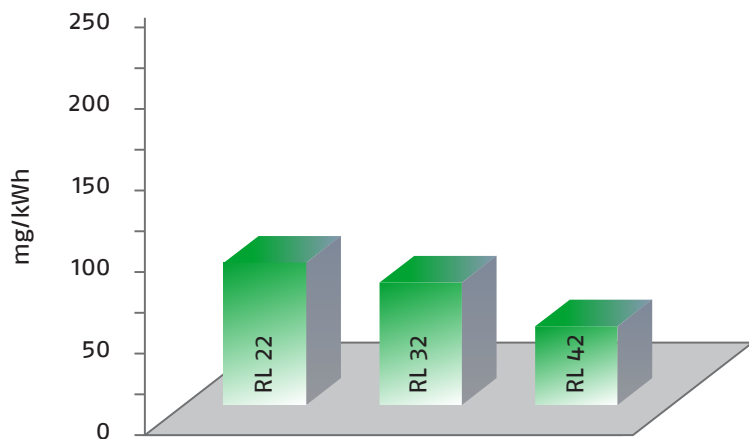

CO EMISSIONS

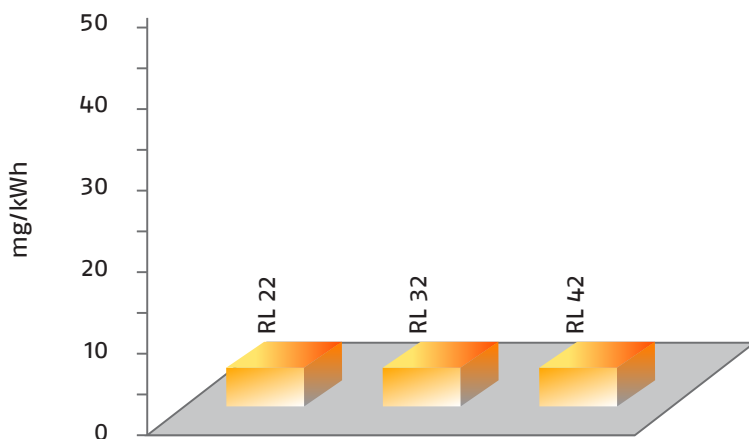

NOISE EMISSIONS

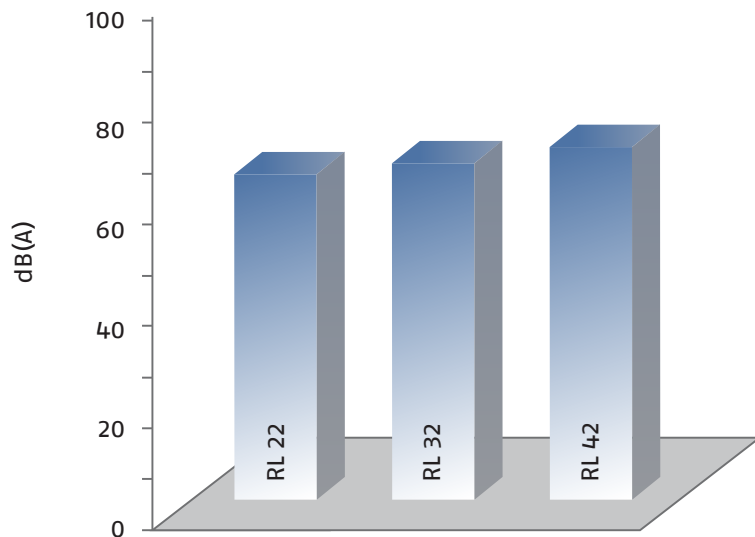

Overall Dimensions (mm)

BURNER

RL 22 - 32 BLU

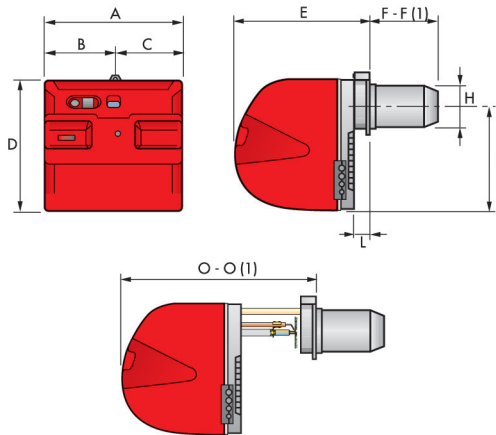

RL 42 BLU

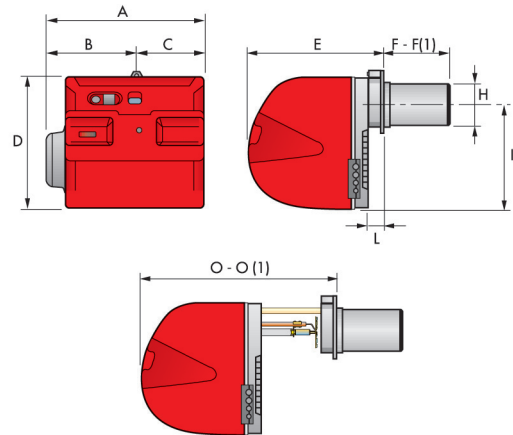

MODEL	A	B	C	D	E	F - F (1)	H	I	L	O - O (1)
RL 22 BLU	476	238	238	474	468	197 - 276	140	352	52	604 - 739
RL 32 BLU	476	238	238	474	468	217 - 293	140	352	52	604 - 739
RL 42 BLU	533	300	238	490	477	295 - 430	179	335	60	680 - 815

BURNER - BOILER MOUNTING FLANGE

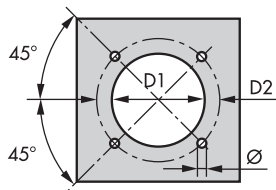

MODEL	D1	D2	Ø
RL 22 BLU	160	224	M8
RL 32 BLU	160	224	M8
RL 42 BLU	185	275-325	M12

PACKAGING

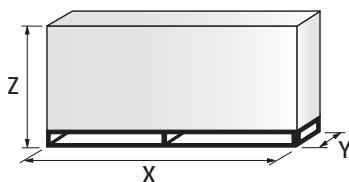

MODEL	X	Y	Z	kg
RL 22 BLU	850	540	550	40
RL 32 BLU	850	540	550	41
RL 42 BLU	1200	560	520	42

Burner Accessories

Nozzles



The nozzles of RL 22 - 32 and 42 BLU burners are chosen on the basis of the maximum output required from the application.

NOTE: each burner needs N° 1 nozzle.

RL 22-32 BLU

GPH	RATED DELIVERY [kg/h] at 8 bar	RATED DELIVERY [kg/h] at 20 bar	DELAVAN 60°A CODE	MONARCH 60°PLP CODE
2.25	7.4	11.9	3042134	3041132
2.50	8.2	13.4	3042144	3041142
3.00	9.9	16.1	3042148	3041152
3.50	11.5	18.8	3042164	3041162
4.00	13.2	21.5	3042174	3041172
4.50	14.8	24.0	3042184	3041182
5.00	16.5	26.8	3042194	3041192
5.50	18.1	29.5	3042204	3041202
6.00	19.8	32.2	3042214	3041212

RL 42 BLU

GPH	RATED DELIVERY [kg/h] at 8 bar	RATED DELIVERY [kg/h] at 20 bar	DELAVAN 45°A CODE
6.00	20.4	31.7	20011679
6.50	22.1	34.5	20024162
7.00	23.8	37.1	20024163
7.50	25.5	40.0	20024164
8.00	27.2	42.5	20024165
8.50	28.9	45.5	20024166
9.00	30.6	48.0	20024167
9.50	32.3	51.0	20024168
10.00	34.0	53.5	20024169

Extended head kit

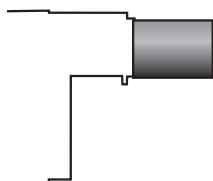

“Standard head” burners can be transformed into “extended head” versions, by using the special kit.

BURNER	STANDARD HEAD LENGTH (mm)	EXTENDED HEAD LENGTH (mm)	KIT CODE
RL 22 BLU	197	276	3010204
RL 32 BLU	217	293	3010205
RL 42 BLU	295	430	20024155

Sound proofing box

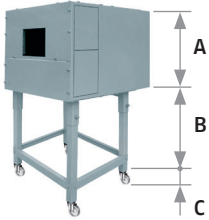

If noise emission needs reducing even further, sound-proofing boxes are available.

In case of generator heights, where a lower dimension "B" is required, ask for the Box Support Kit code 20065135.

BURNER	BOX TYPE	A (mm)	B (mm) min-max	C (mm)	[dB(A)] (*)	BOX CODE
RL 22 BLU – RL 32 BLU	C1/3	650	372 – 980	110	10	3010403
RL 42 BLU	C4/5	850	160 – 980	110	10	3010404

(*) Average noise reduction according to EN 15036-1 standard

Degasing unit



To solve problem of air in the oil sucked, two versions of degasing unit are available.

BURNER	FILTER	FILTERING DEGREE (µm)	DEGASING UNIT CODE
All models	With filter	50 – 75	3010055
All models	Without filter	-	3010054

Connection flange kit

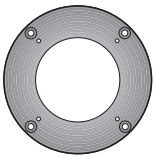

A kit is available for use where the burner opening on the boiler is of excessive diameter.

BURNER	(mm)	KIT CODE
RL 22 BLU – RL 32 BLU	170 (internal diameter) 300 (external diameter)	3010138

Specification

DESIGNATION OF SERIES

A specific index guides your choice of burner. Below is a clear and detailed specification description of the product.

Series: R										
Fuel:		S	Natural Gas							
		SP	LPG							
		L	Light oil							
		LS	Light oil/Methane							
		N	Heavy oil							
Size										
Setting:		/1	Single stage							
		...	Two stage							
		/M	Modulating							
Emission:		...	Class 1 EN267 - EN676							
		MZ	Class 2 EN267 - EN676							
		BLU	Class 3 EN267 - EN676							
		MX	Class 1 EN267 Class 3 EN676							
Head length:		TC	standard head							
		TL	extended head							
Flame control system:		FS1	Standard (1 stop every 24 h)							
		FS2	Continuous working (1 stop every 72 h)							
Electrical supply to the system:										
		1/230/50	1/230V/50Hz							
		1/220-230/50-60	1/220-230V/50-60Hz							
		3/230/50	3/230V/50Hz							
		3/400/50	3N/400V/50Hz							
		3/230-400/50	3/230V/50Hz - 3N/400V/50Hz							
		3/220/60	3/220V/60Hz							
		3/380/60	3N/380V/60Hz							
		3/220-380/60	3/220V/60Hz - 3N/380V/60Hz							
		3/220-230/50-60	3/220-230V/50-60Hz							
		3/220-400/50-60	3/380-400V/50-60Hz							
Auxiliary voltage:		230/50-60	230V/50-60Hz							
		220-230/50-60	220-230V/50-60Hz							
		110/50-60	110V/50-60Hz							
ID:		Differential switch								

R	L	22		BLU	TC	FS1	1/230/50	230/50-60	
BASIC DESIGNATION				EXTENDED DESIGNATION					

AVAILABLE BURNER MODELS

RL 22 BLU	TC	FS1	1/230/50	230/50-60
RL 22 BLU	TL	FS1	1/230/50	230/50-60
RL 32 BLU	TC	FS1	1/230/50	230/50-60
RL 32 BLU	TL	FS1	1/230/50	230/50-60
RL 42 BLU	TC	FS1	3/230-400/50	230/50-60

Other versions are available on request.

PRODUCT SPECIFICATION

Monoblock forced draught Low NOx oil burner with completely automatic two stage operation, made up of:

- Air suction circuit lined with sound-proofing material
- Fan with reverse curve blades (RL 22-32 BLU models) or forward blades (RL 42 BLU model)
- Air damper for air setting, driven by the adjustable servomotor
- Low emission combustion head, that can be set on the basis of required output
- Gears pump for high pressure fuel supply
- Two oil valves fitted directly on to the pump
- UV sensor for flame detection
- Microprocessor-based burner safety control box, with diagnostic function
- Burner on/off switch
- Manual high/low flame switch
- Flame inspection window
- Slide bars for easier installation and maintenance
- Protection filter against radio interference
- IP 44 electric protection level.

Standard equipment:

- 2 flexible pipes for connection to the oil supply network
- 2 gaskets for the flexible pipes
- 2 nipples for connection to the pump
- 1 thermal screen
- 4 screws for fixing the burner flange to the boiler
- Wiring loom fittings for electrical connections
- Instruction handbook for installation, use and maintenance
- Spare parts catalogue.

Riello Burners a world of experience in every burner we sell.

01/2016
TS0014UK03



[1]

Across the world, Riello sets the standard in reliable and high efficiency burner technology.

With burner capacity from 5 kW to 48 MW, Riello gas, oil, dual fuel and Low Nox burners deliver unbeatable performance across the full range of residential and commercial heating applications, as well as in industrial processes.

With headquarter in Legnago, Italy, Riello has been manufacturing premium quality burners for over 90 year. The manufacturing plant is equipped with the most innovative systems of assembling lines and modern manufacturing cells for a quick and flexible response to the market.



[2]

Besides, the Riello Combustion Research Centre, located in Angiari, Italy, represents one of the most modern facility in Europe and one of the most advanced in the world for the development of the combustion technology.

Today, the company's presence on worldwide markets is distinguished by a well-constructed and efficient sales network, alongside many important Training Centres located in various countries to meet its customers' needs. Riello has 13 operational branches abroad (in Europe, America and Asia), with customers in over 60 countries.

[1] BURNERS PRODUCTION PLANT
S. PIETRO, LEGNAGO (VERONA) - ITALIA

[2] HEADQUARTER BURNERS DIVISION
S. PIETRO, LEGNAGO (VERONA) - ITALIA

RIELLO S.p.A. - 37045 Legnago (VR) - Italy
tel. +39 0442 630111 - fax: +39 0442 21980
www.riello.com

Since the Company is constantly engaged in the production improvement, the aesthetic and dimensional features, the technical data, the equipment and the accessories can be changed. This document contains confidential and proprietary information of RIELLO S.p.A. Unless authorised, this information shall not be divulged, nor duplicated in whole or in part.

RIELLO